

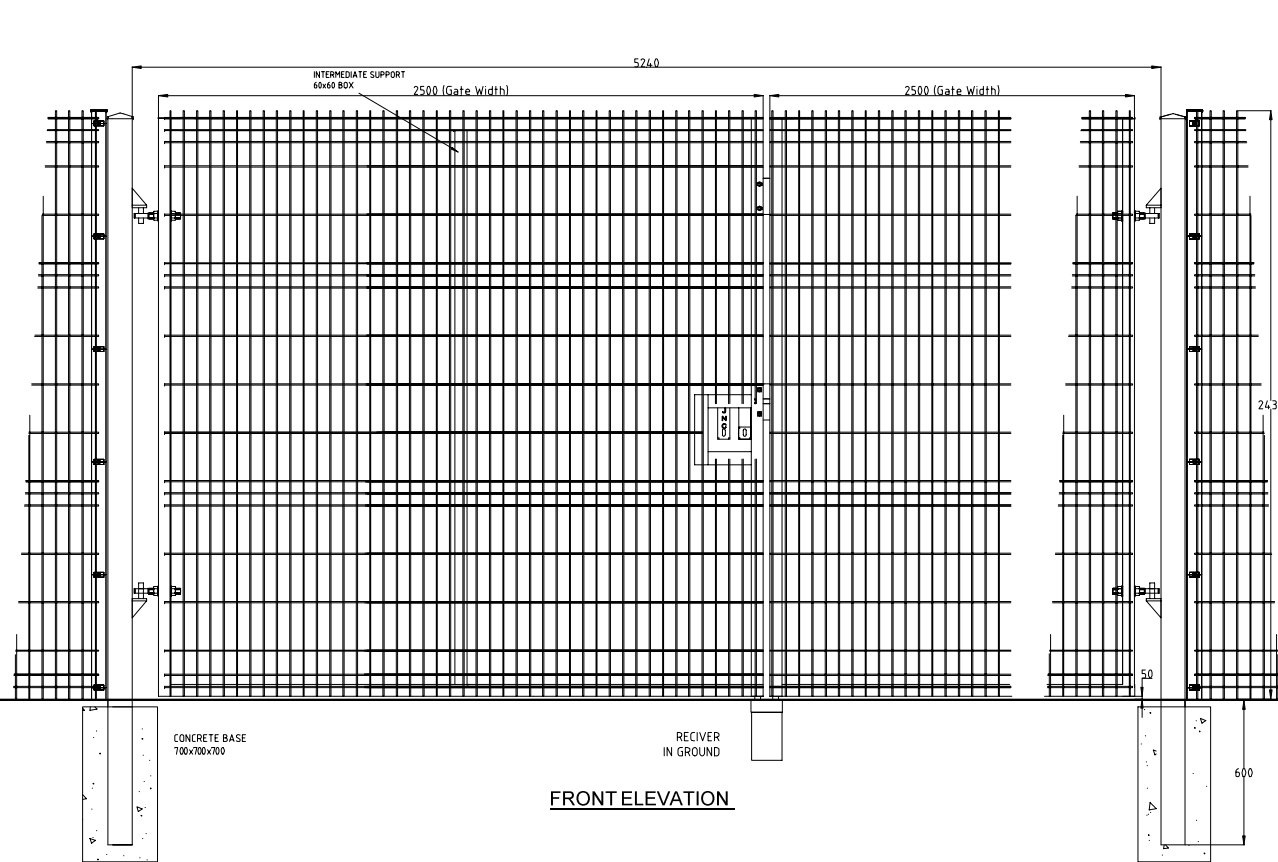

IMPORTANT: NOTE. SAMPLE DRAWING ONLY ACTUAL DIMENSION MAY CHANGE. **DO NOT SCALE**

JNC RESISTA MESH 5M D.L GATE



FRONT ELEVATION

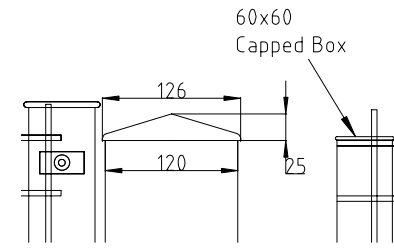

POST CAP DETAIL

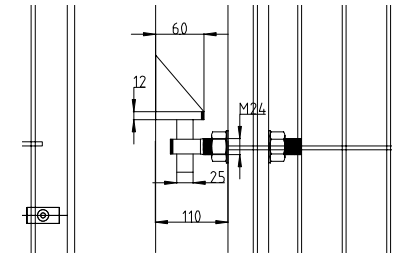

HINGE DETAIL

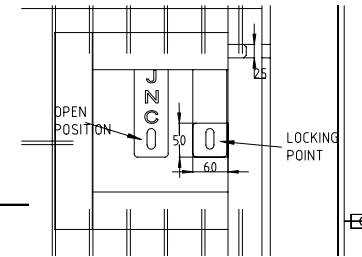

LOCK DETAIL

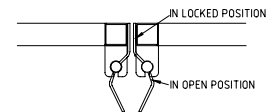
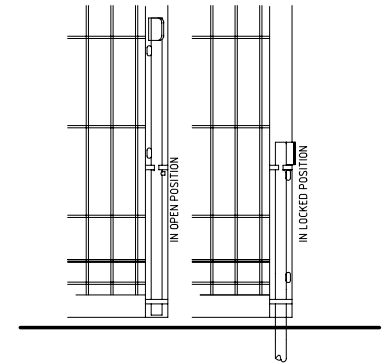

LOCK DETAIL

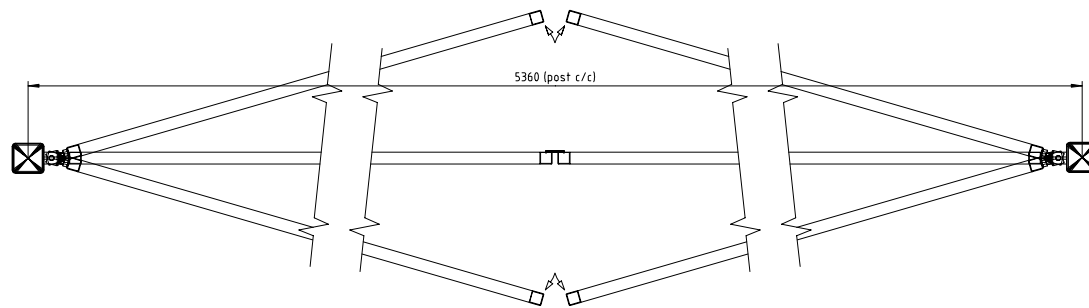

PLANVIEW

NOTE. 2.4 M High fence shown

Drawing Title: JNC RESISTA 5M W: 2.4MH D.L HANGING GATE	
Project/ Client:	SAMPLE DRAWING
Drawing/Doc.No:	Ref. No. MPG-R-04/ (*)
Date: 18/07/16	By: JD App: JNC FENCING

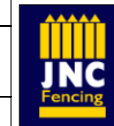

J.N.CUMMINS & Co.LTD
 Industrial Fencing Contractors
 Supply / Supply and Erection
 Mayfield, Cashel, Co Tipperary
 Tel: 00353 62 62214 Fax: 00353 62 62947
 e-Mail info@jncfence.com
 www.jncfence.com